

O'clock

idiomas

SUMMER HOMEWORK

Level Pre-A1

Name: _____

BASIC SKILLS FOR PRESCHOOLERS



FUN AND LEARN



ISBN: 1 86476 067 2

Copyright © Axiom Publishing, 2001.

This book is copyright. Apart from any fair dealing for the purpose of private study, research, criticism or review, as permitted under the Copyright Act, no part may be reproduced by any process without written permission. Enquiries should be made to the publisher.

COLOURING IN

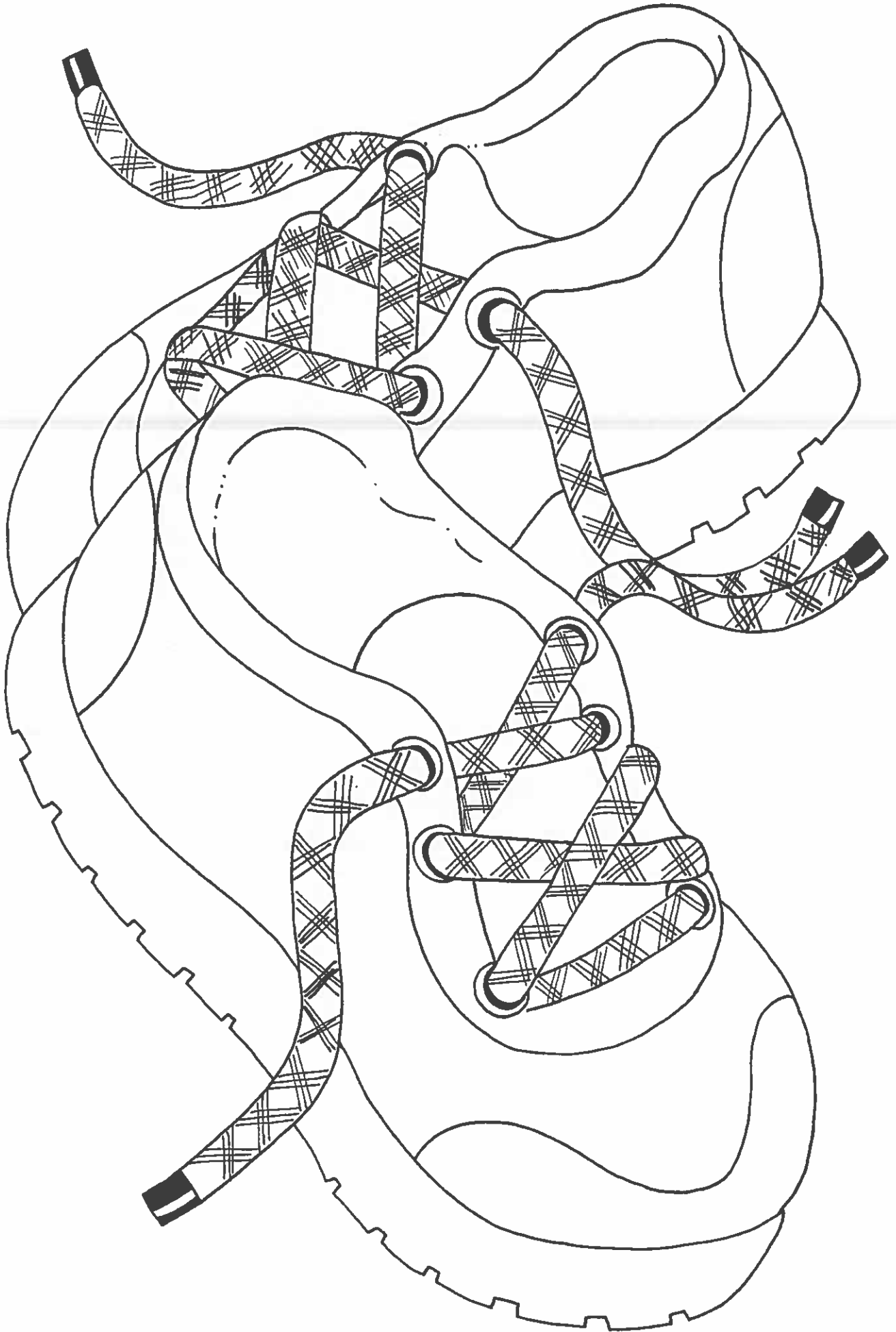

JIGSAW

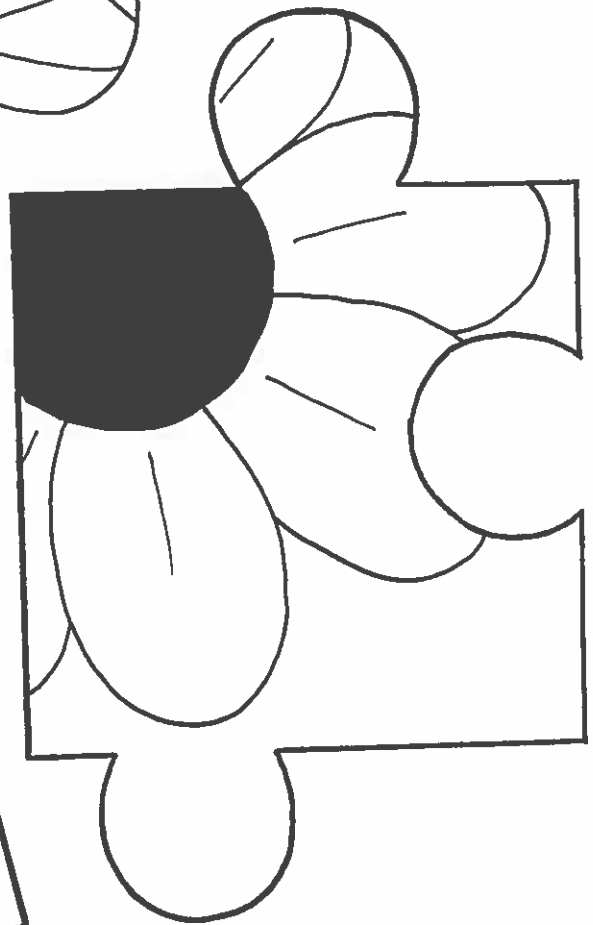
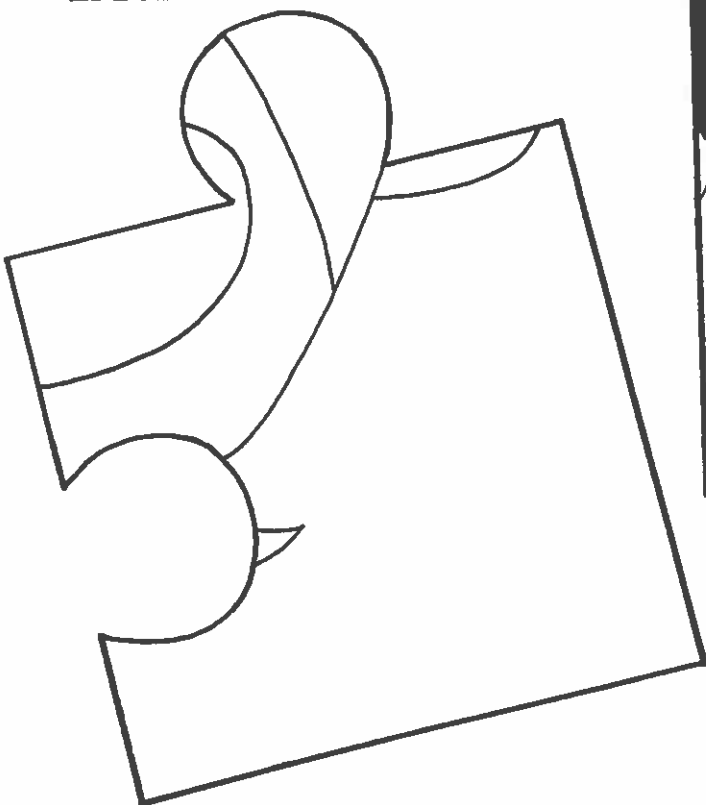
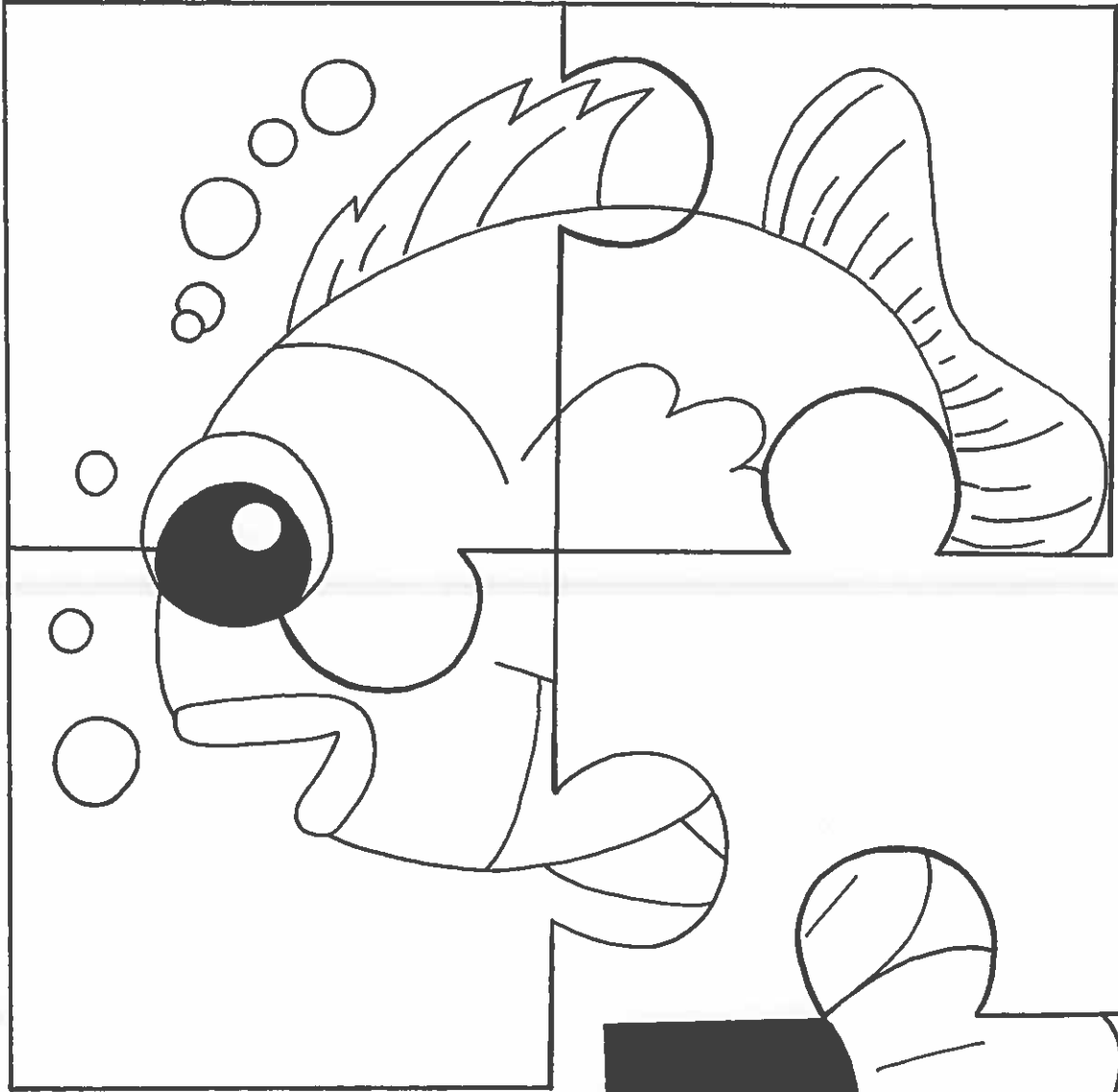

Which is the correct piece?

SIMILARITIES

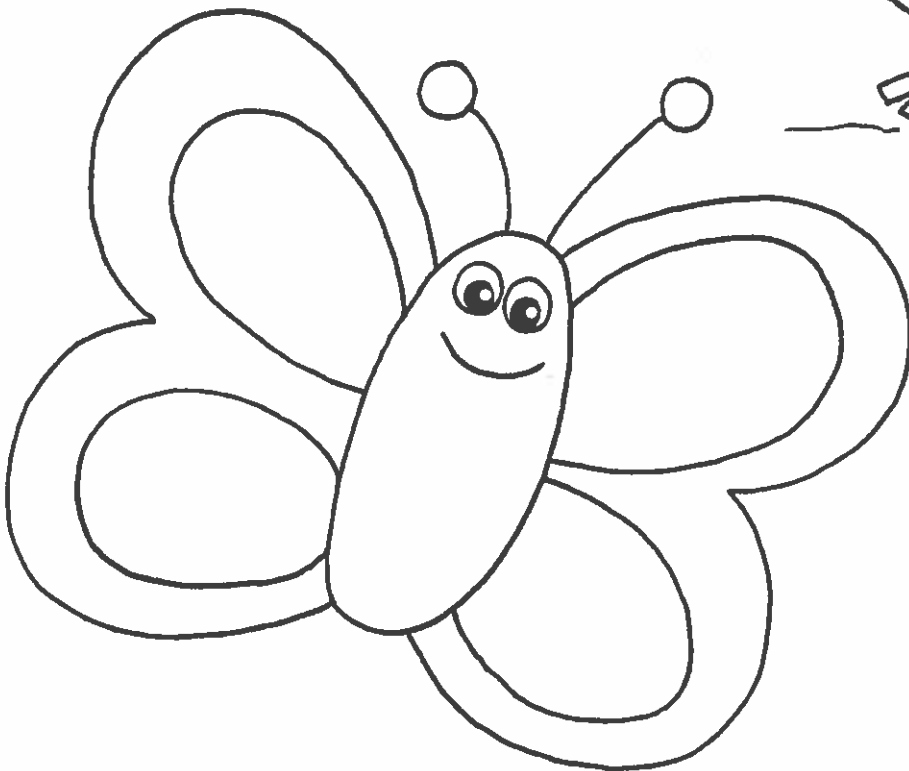
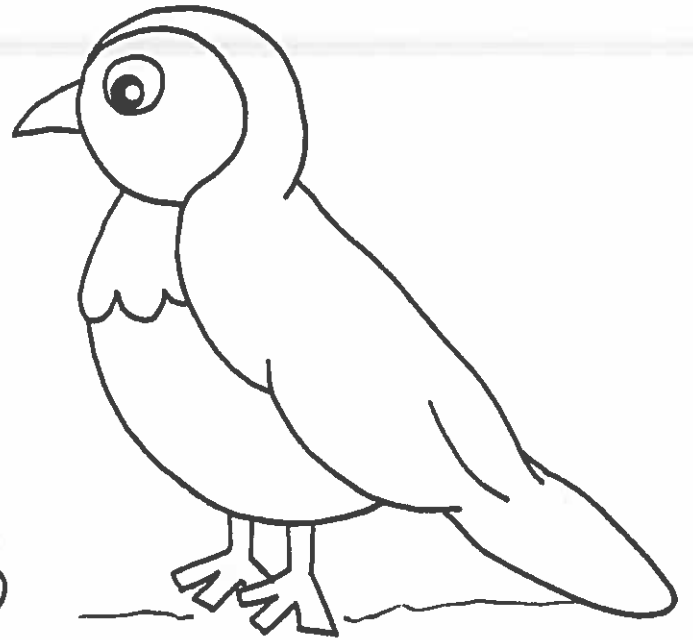
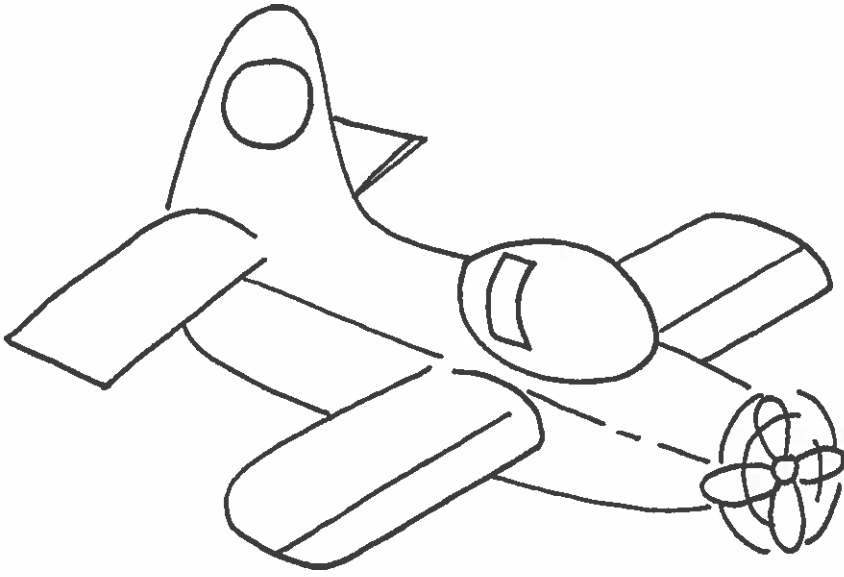

What do these objects have in common?

DRAWING

Draw what is on TV.

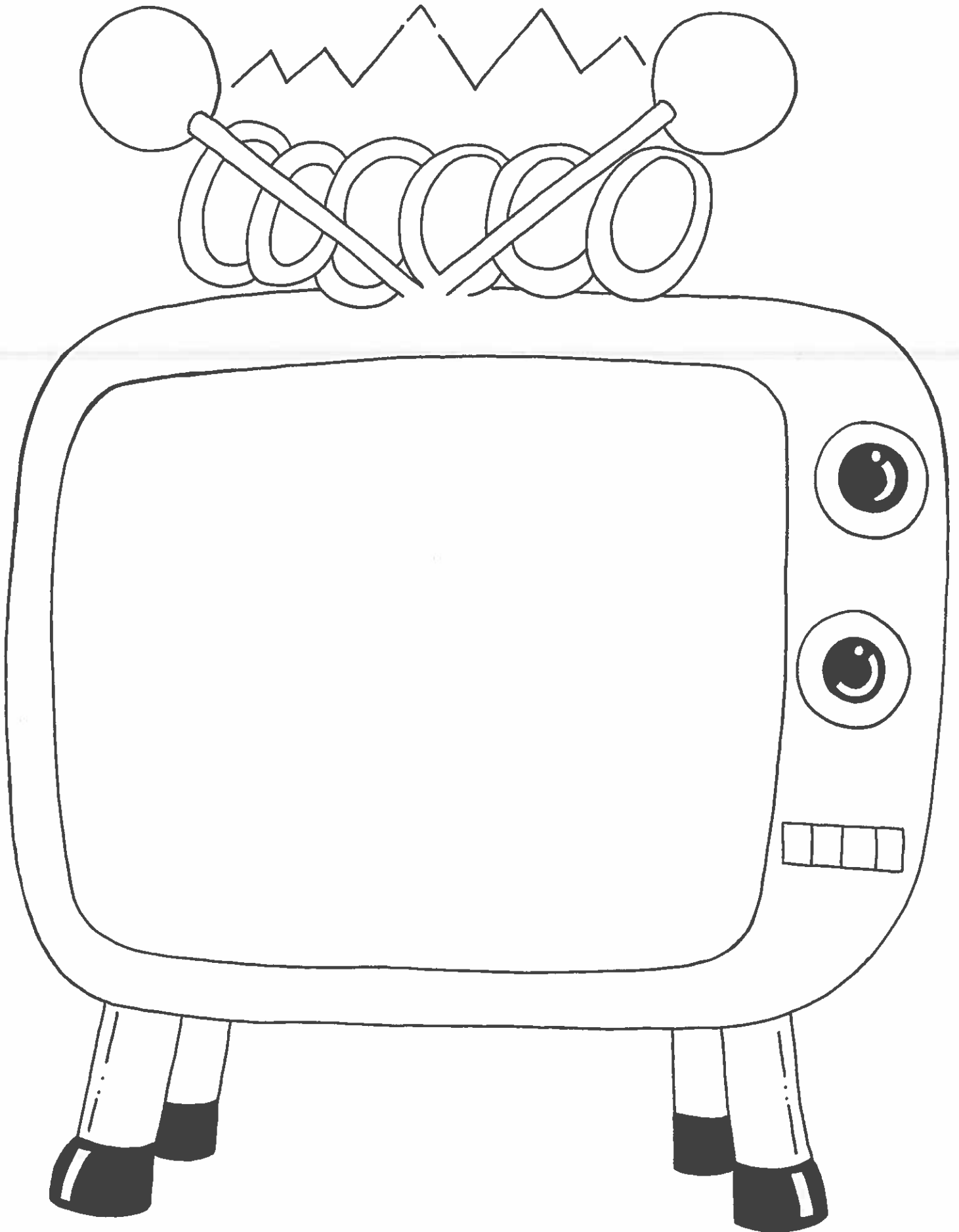

NUMBERS

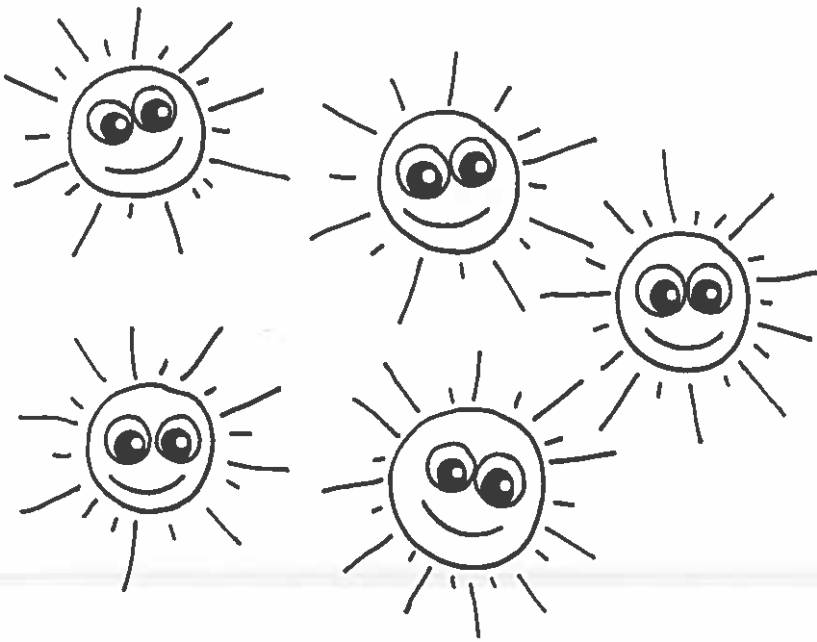

Draw some more suns to make 11.

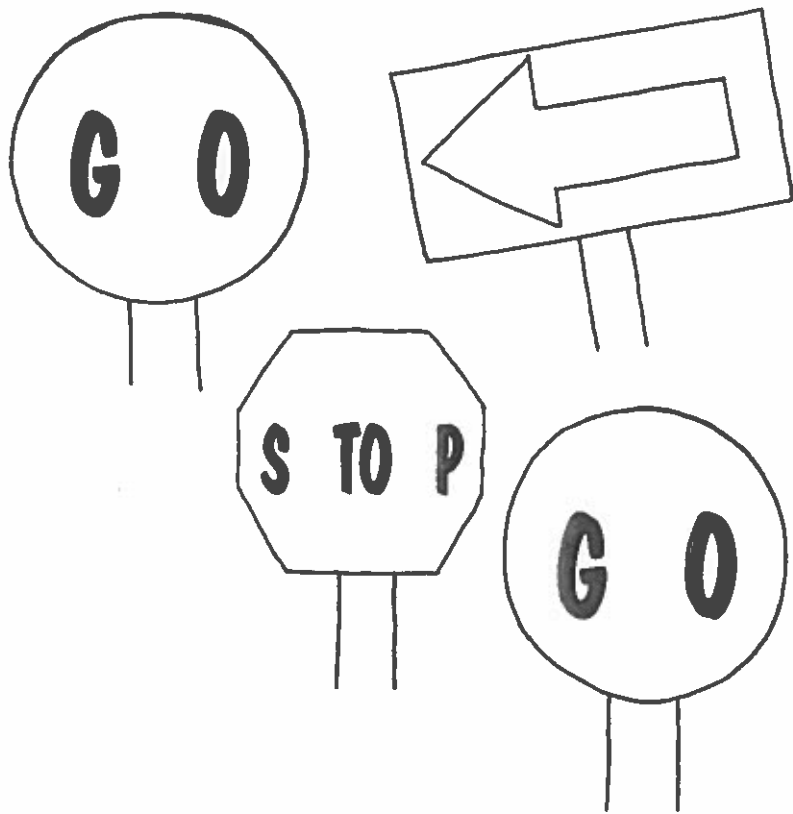

Draw some more signs to make 8.

Monsters



LETTER SKILLS



Ice Cream



DRAWING

The barbeque is ready to cook. We need:

2 eggs **4** sausages

3 onions **2** steaks

Draw the food on
the barbeque.

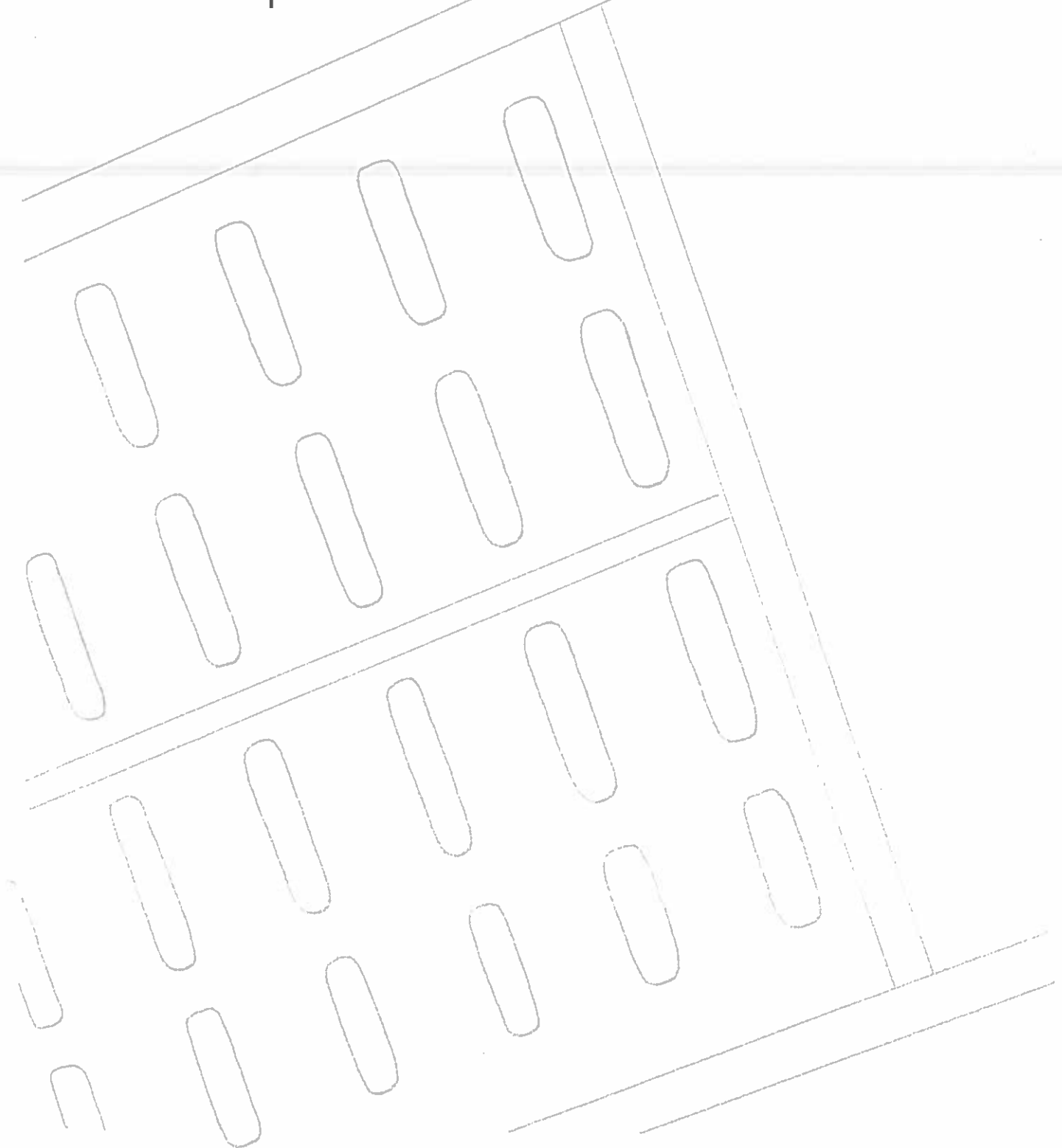

NUMBERS

Draw and colour in the missing number.

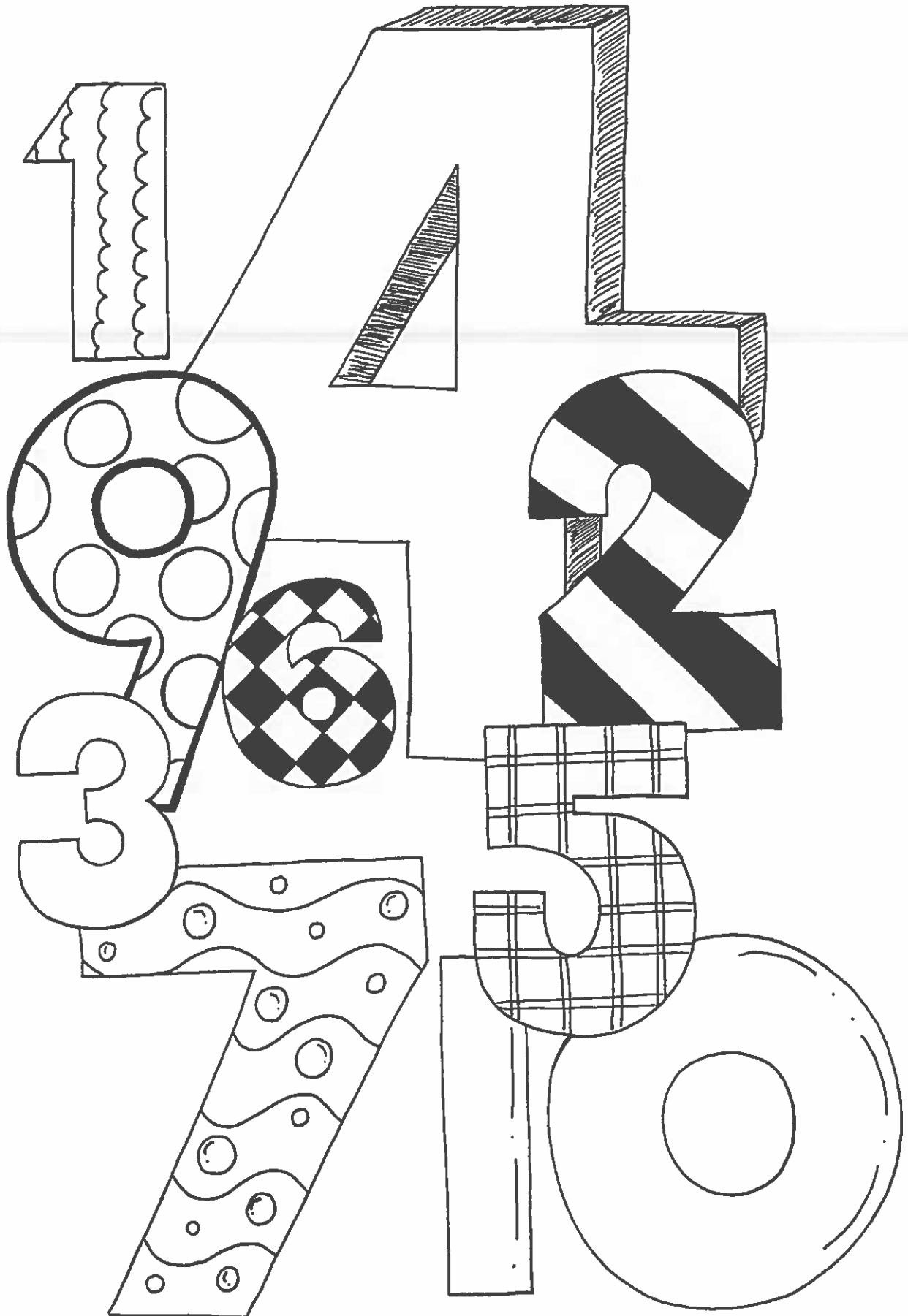

COLOURING IN



LETTER SKILLS

V

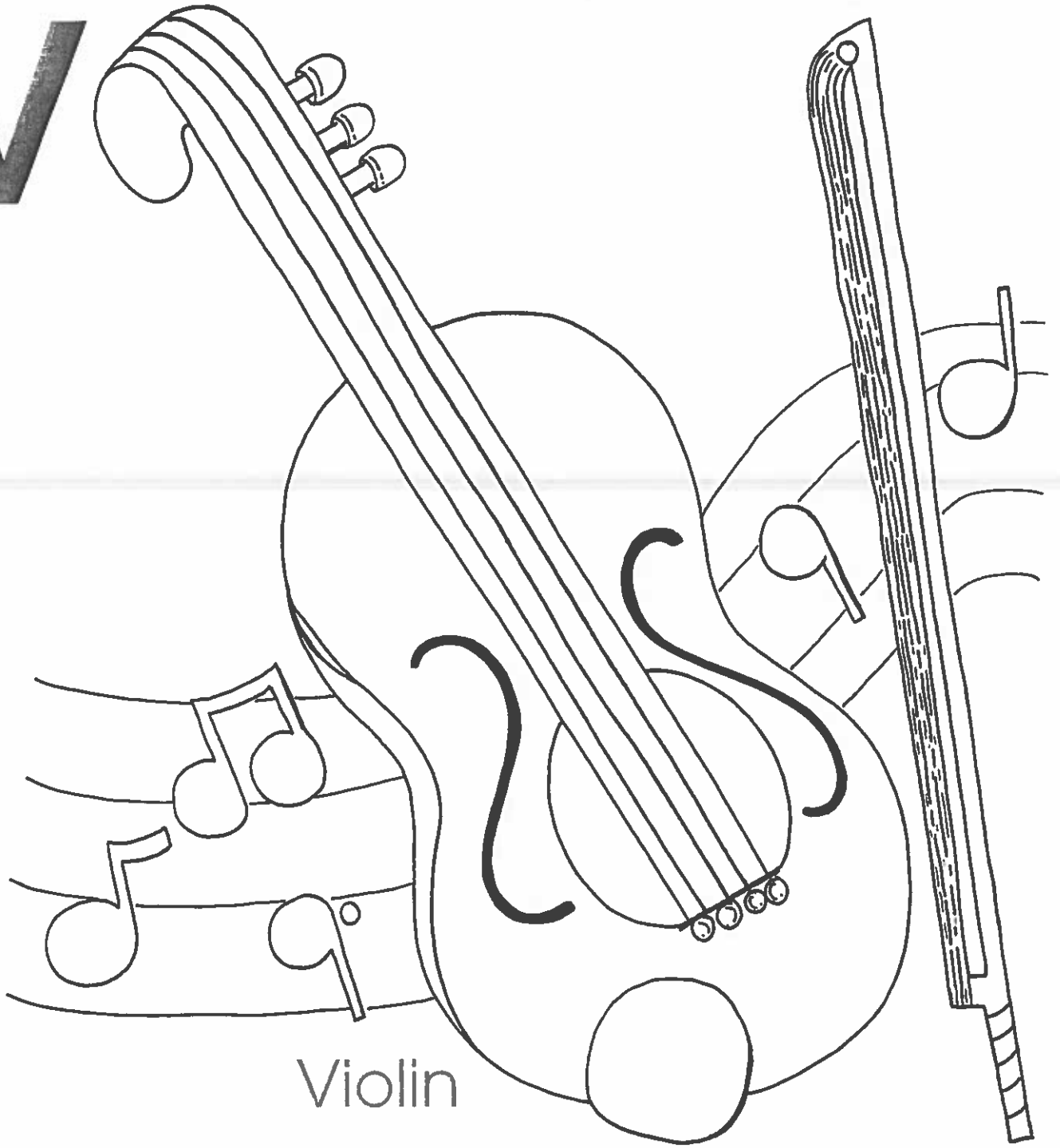

Violin

V

V

DRAWING

Finish drawing the clown, then colour him in.

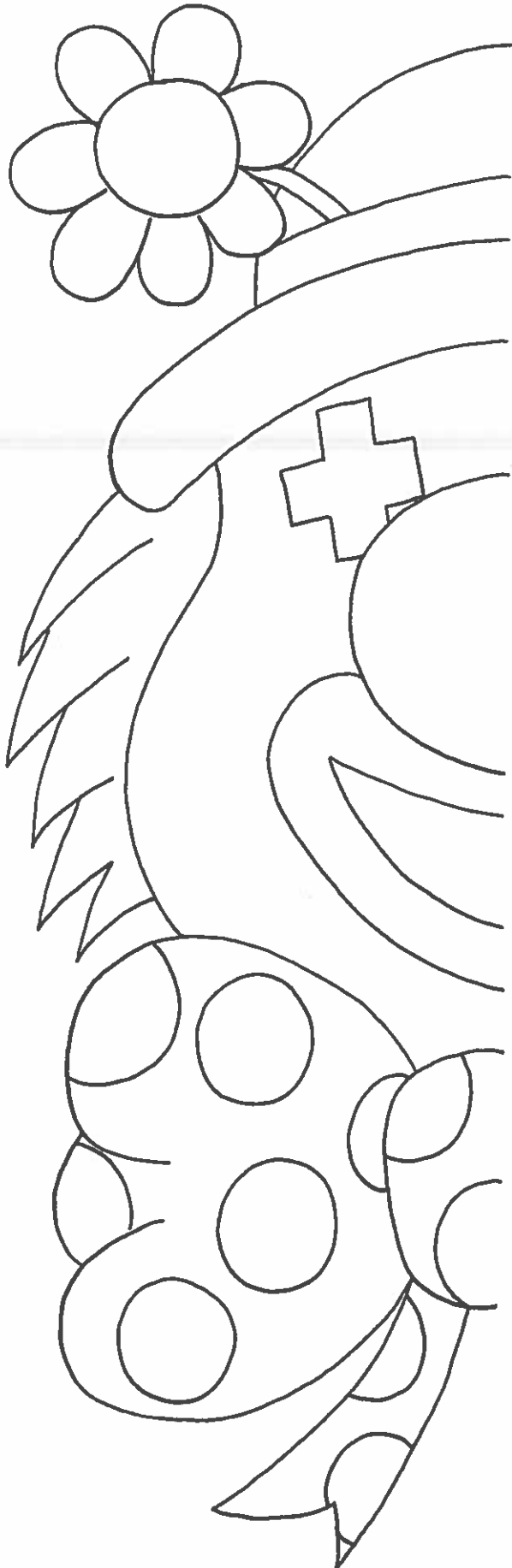

$2 + 2 =$

$4 + 4 =$

$5 + 6 =$

$3 + 2 =$

$7 + 1 =$

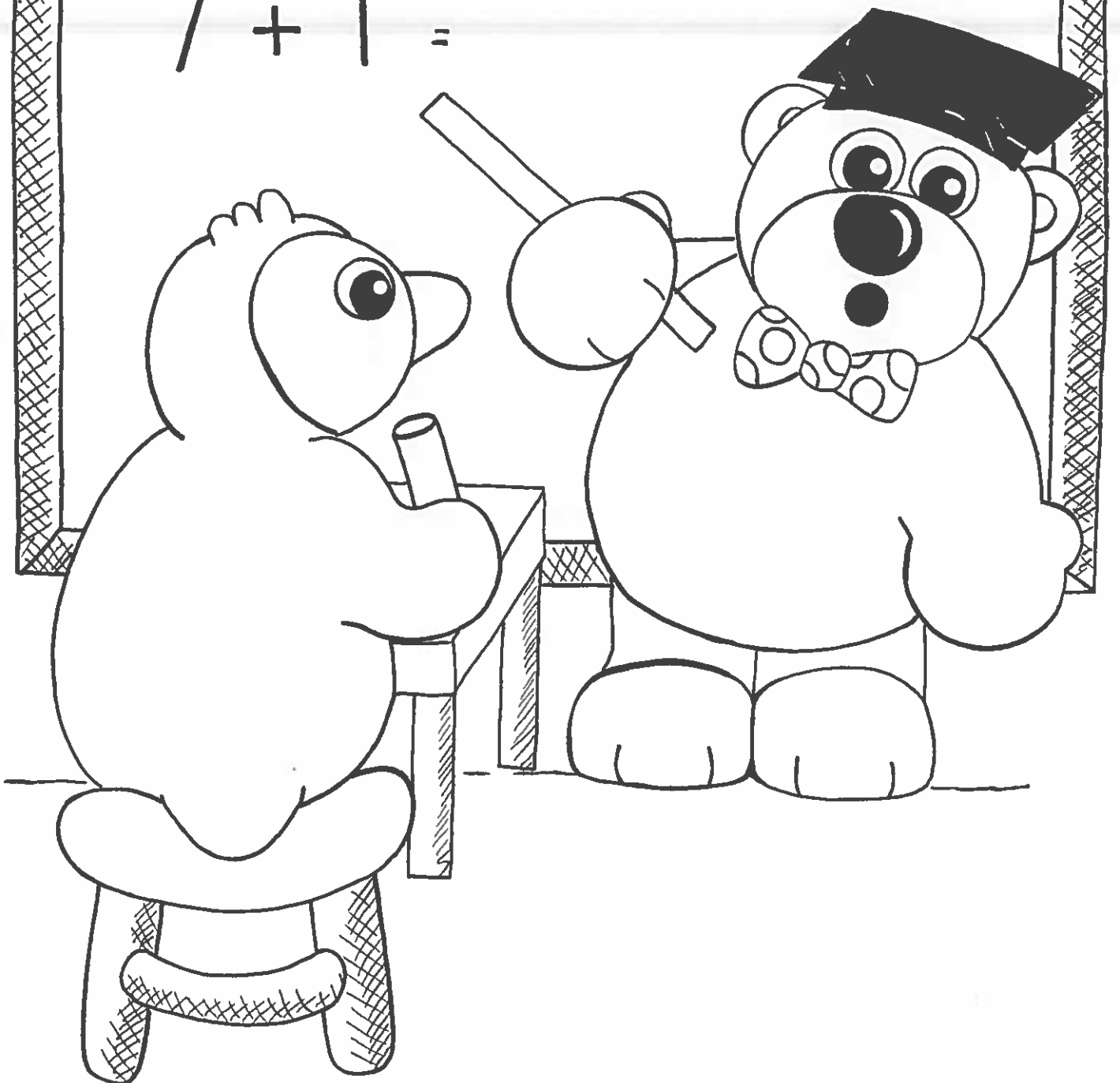

Circus time

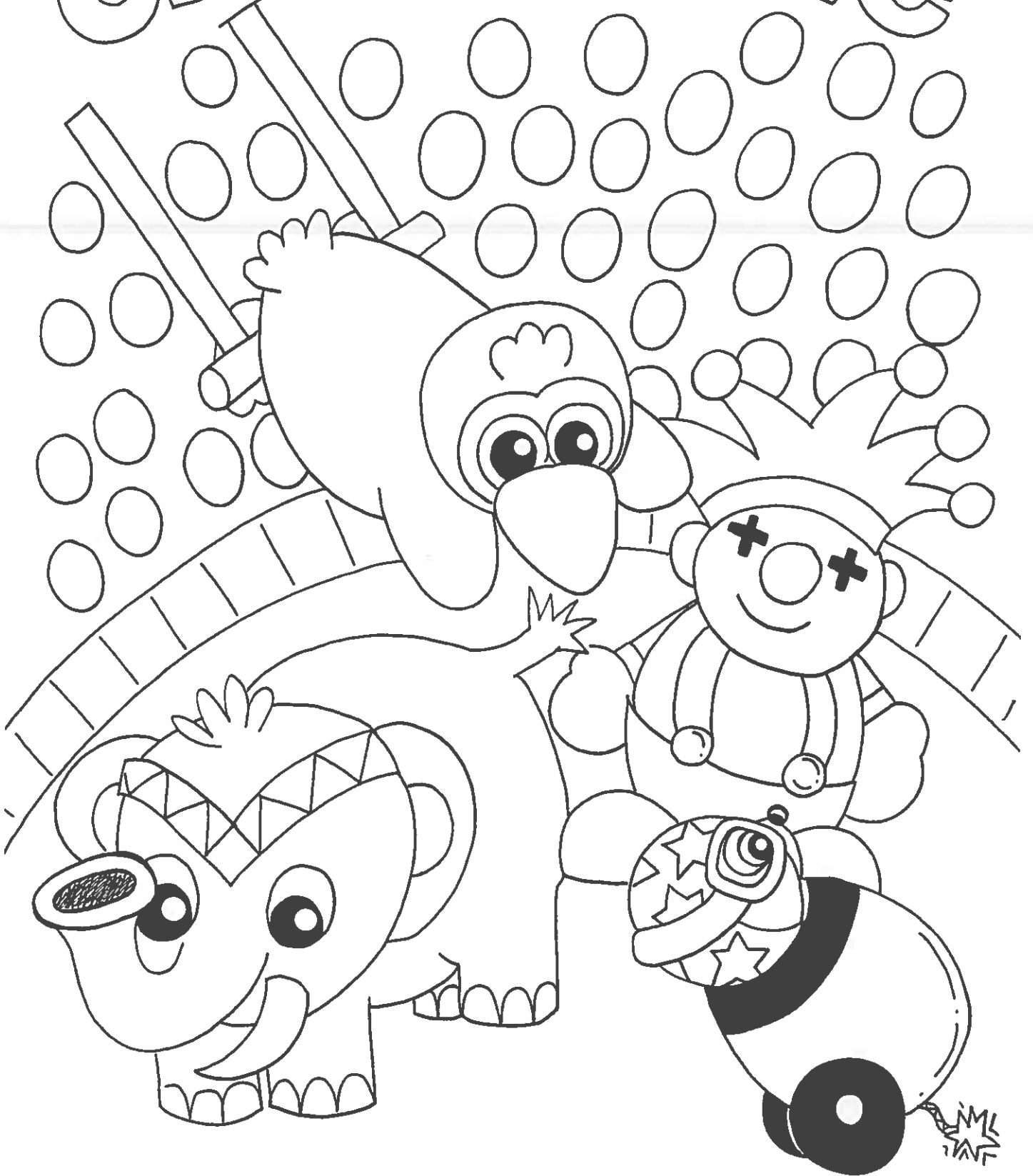

OPPOSITES

big

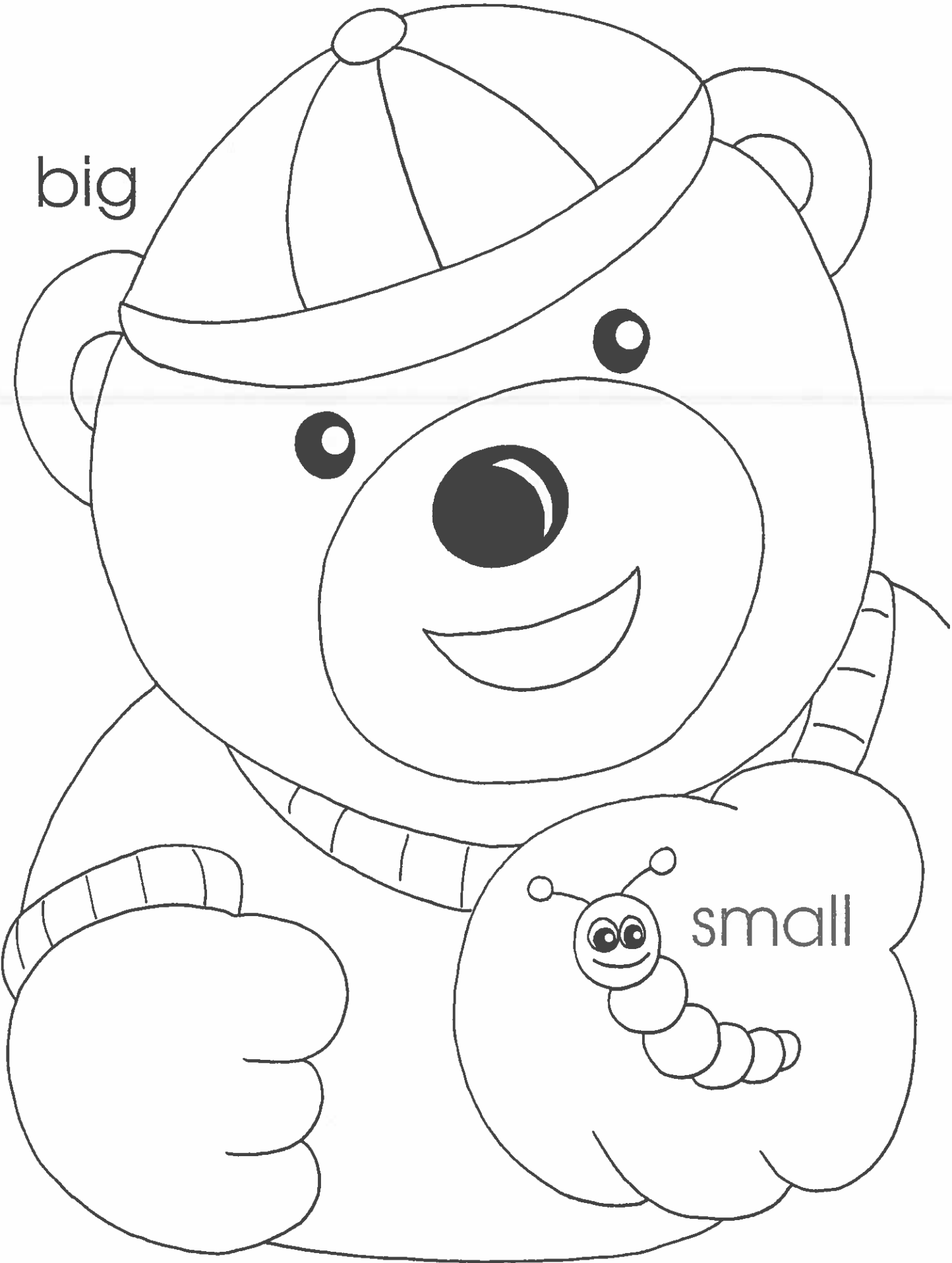

small

SEASONS

What season is this?

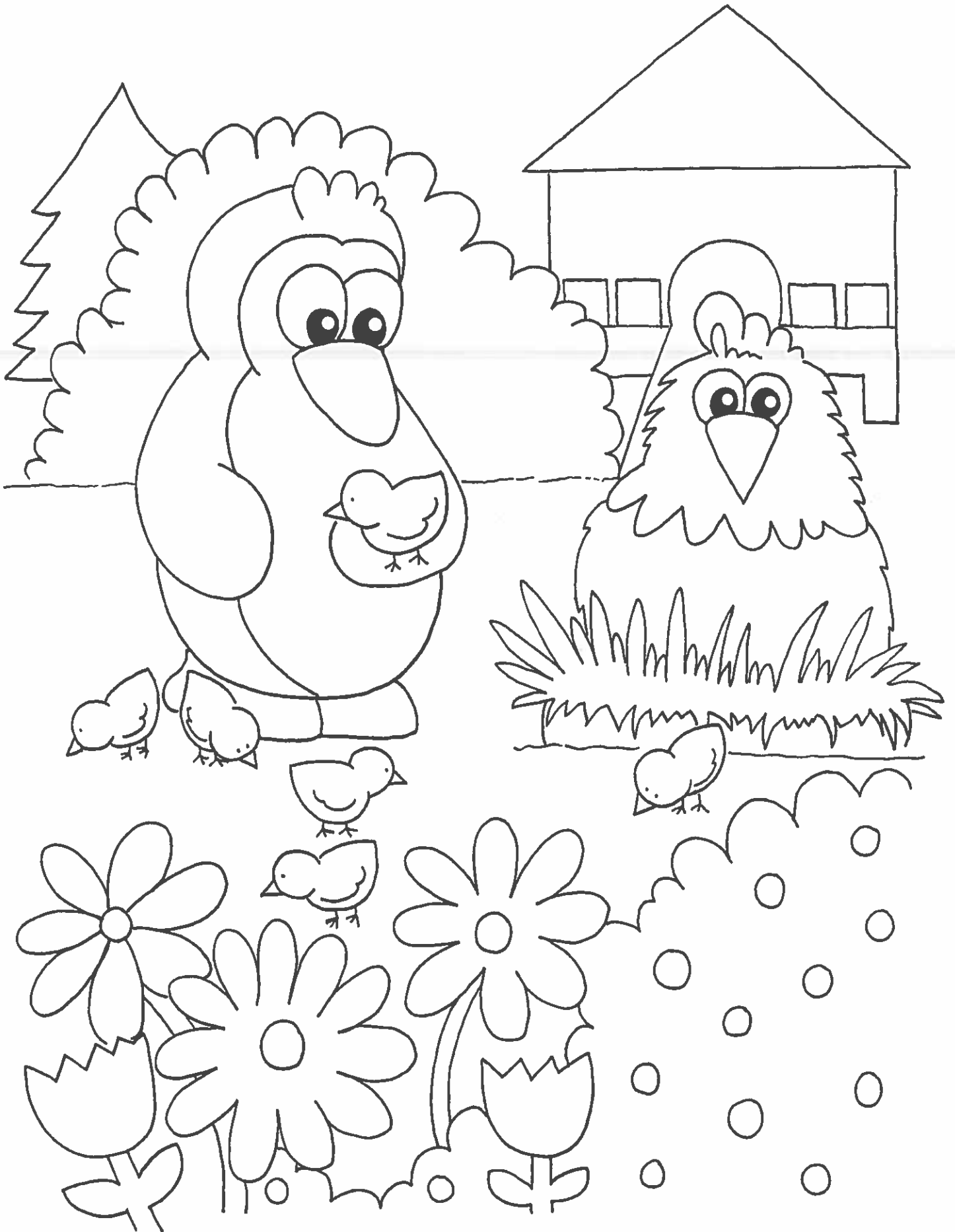

COUNTING

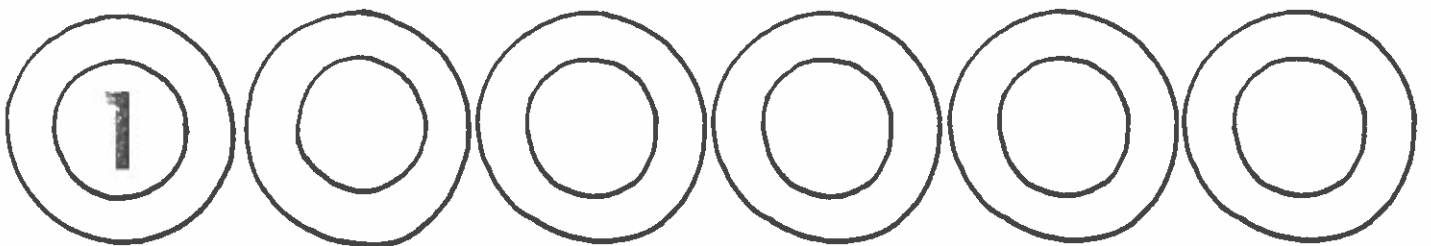
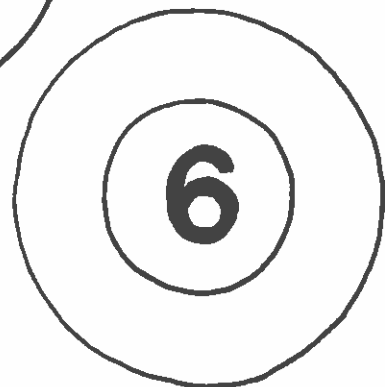
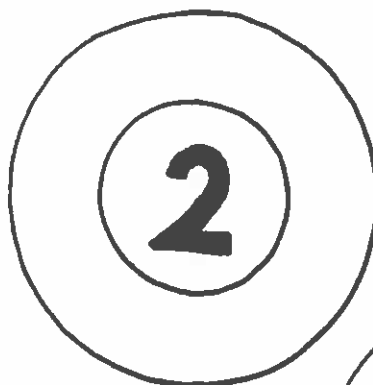
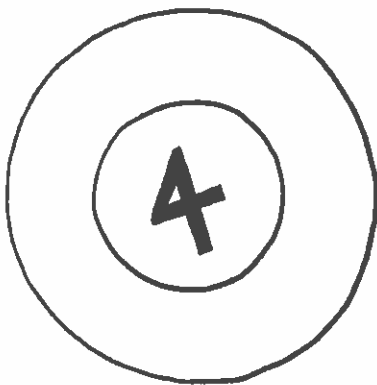
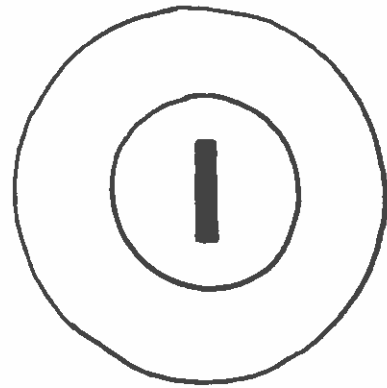
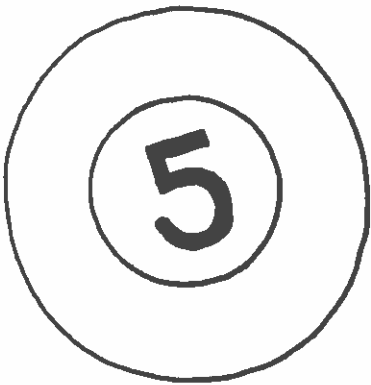

In order, write the numbers on the snooker balls.



Goodnight

T

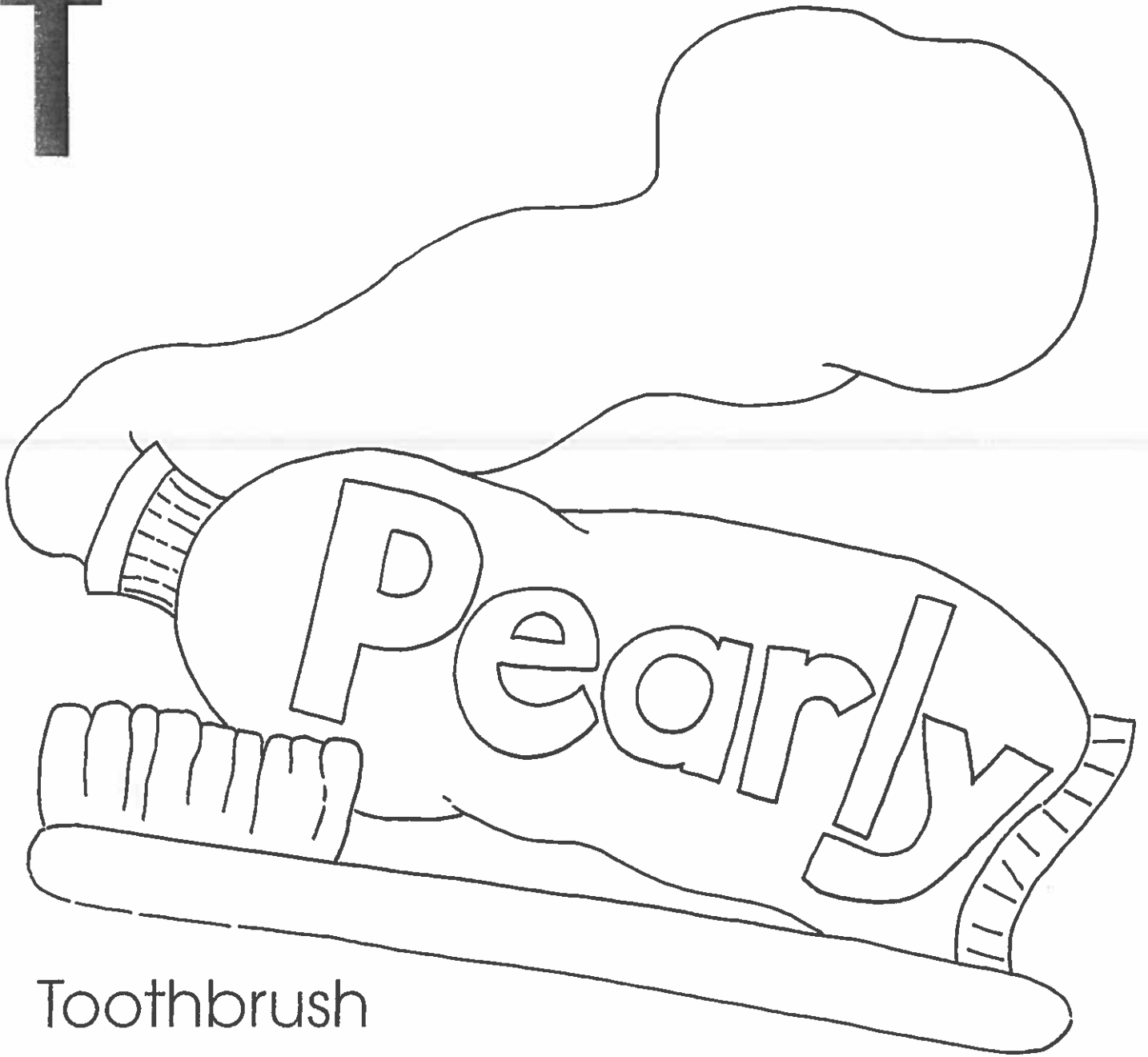

Toothbrush

T

t

DRAWING

Draw two animals you are likely to see at the zoo.

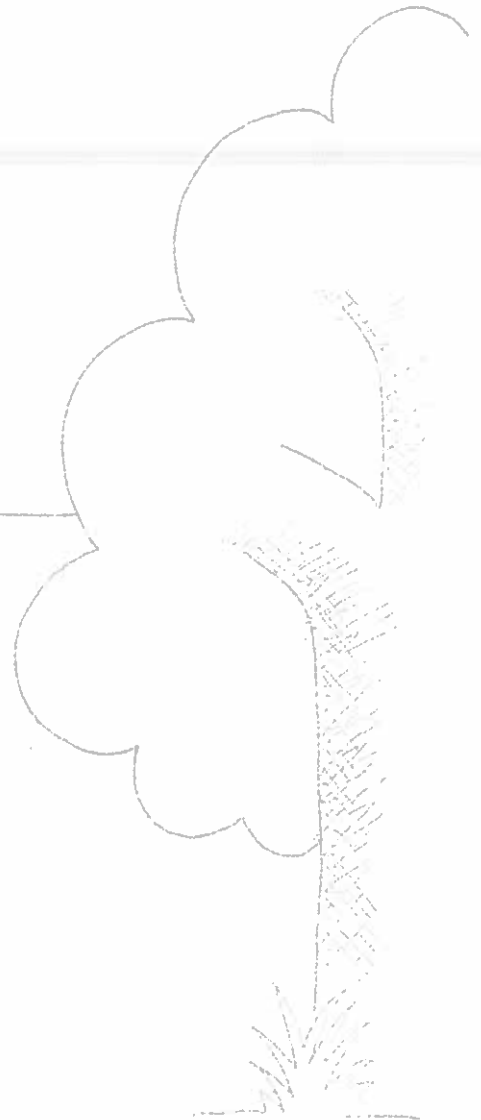
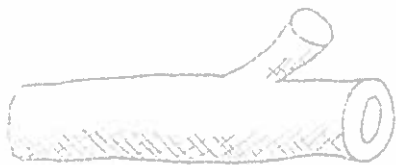
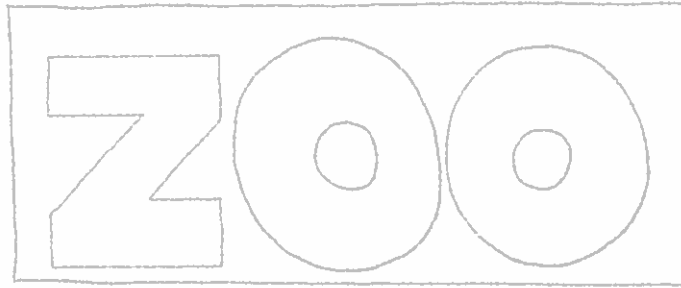

COUNTING

Count how many biscuits have fallen off the tray.

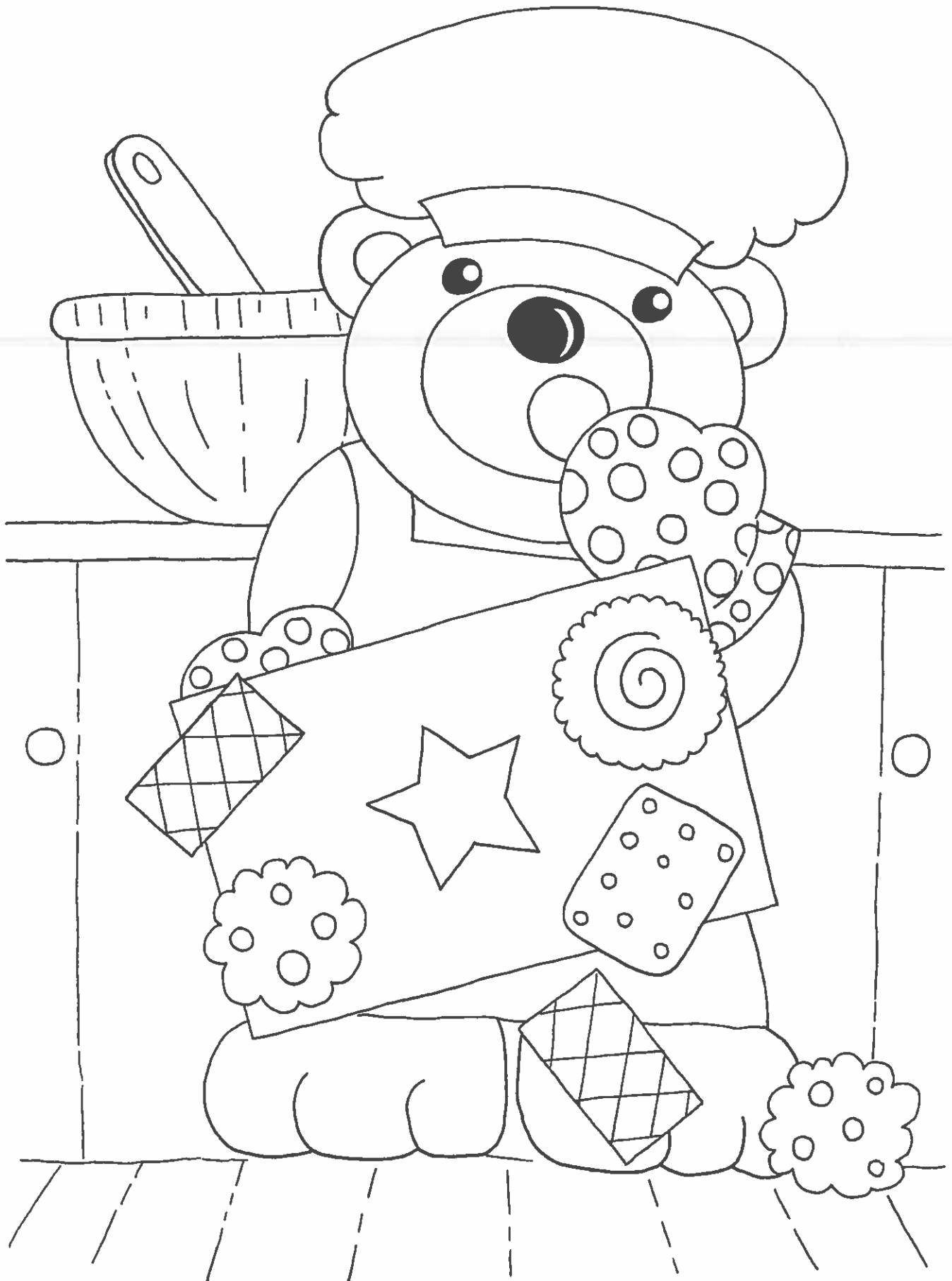

COLOURING IN

Colour in: 6 books red, 4 books yellow
and 3 books in green.

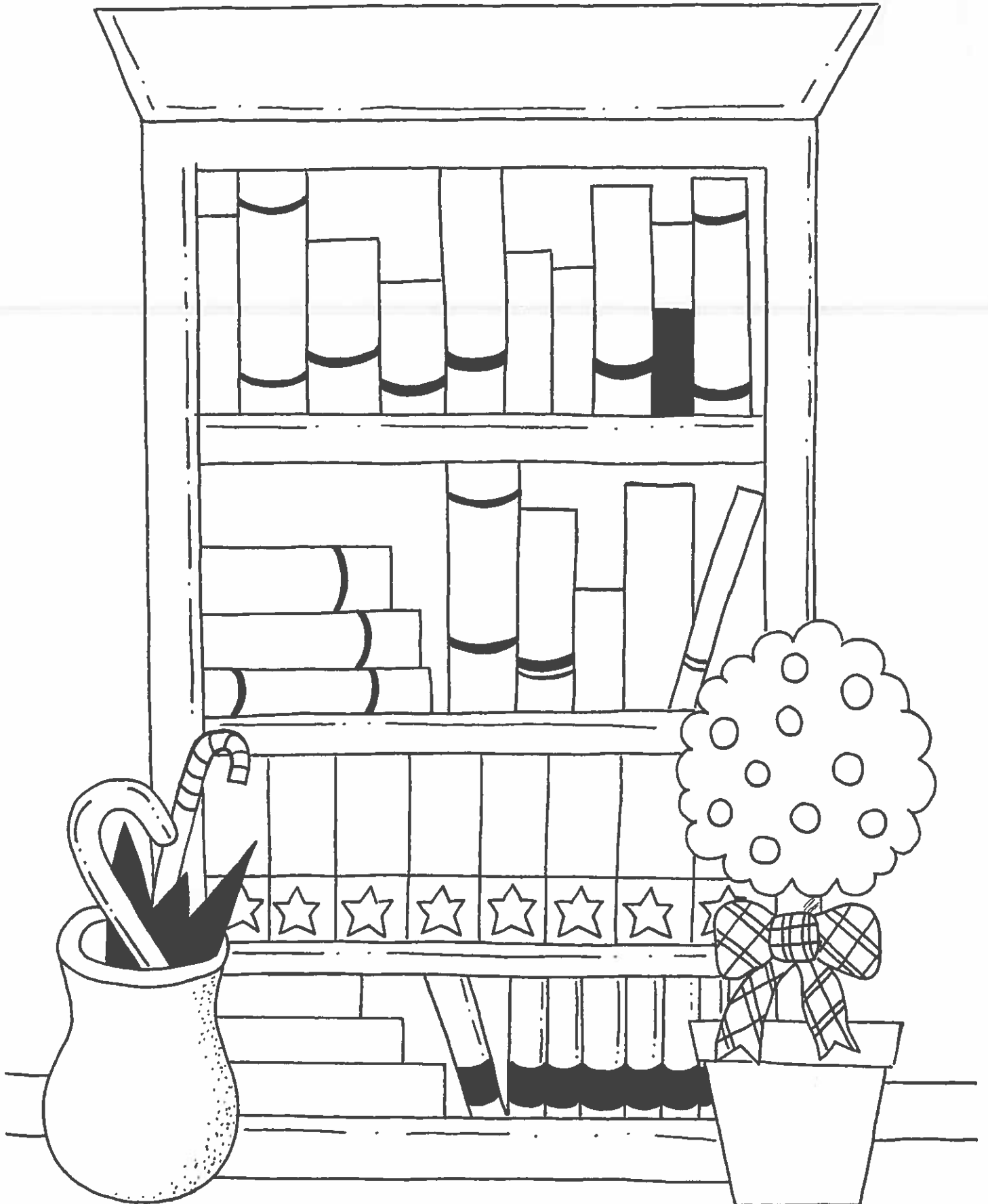

H



House

H
h

DRAW YOUR PETS

How many pets do you have? _____

NUMBERS

Colour in the boxes to match the numbers.

2



9

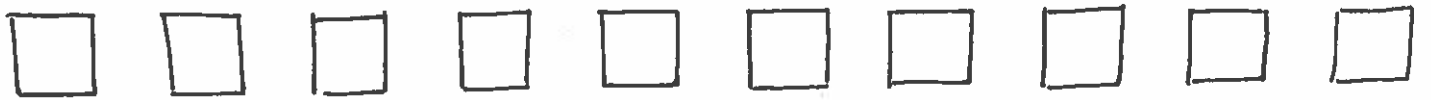

4



6



5



COLOURING IN

Colour in the bear on his mountain bike.



OPPOSITES

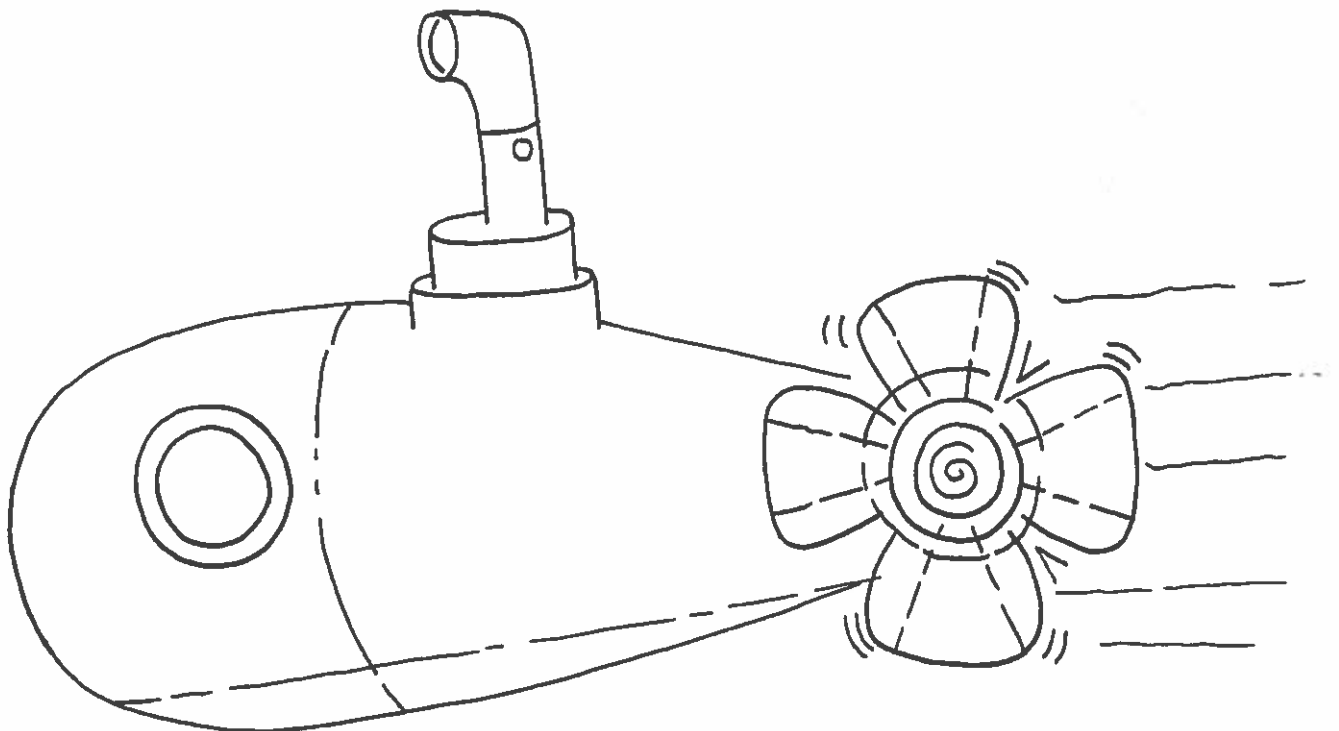
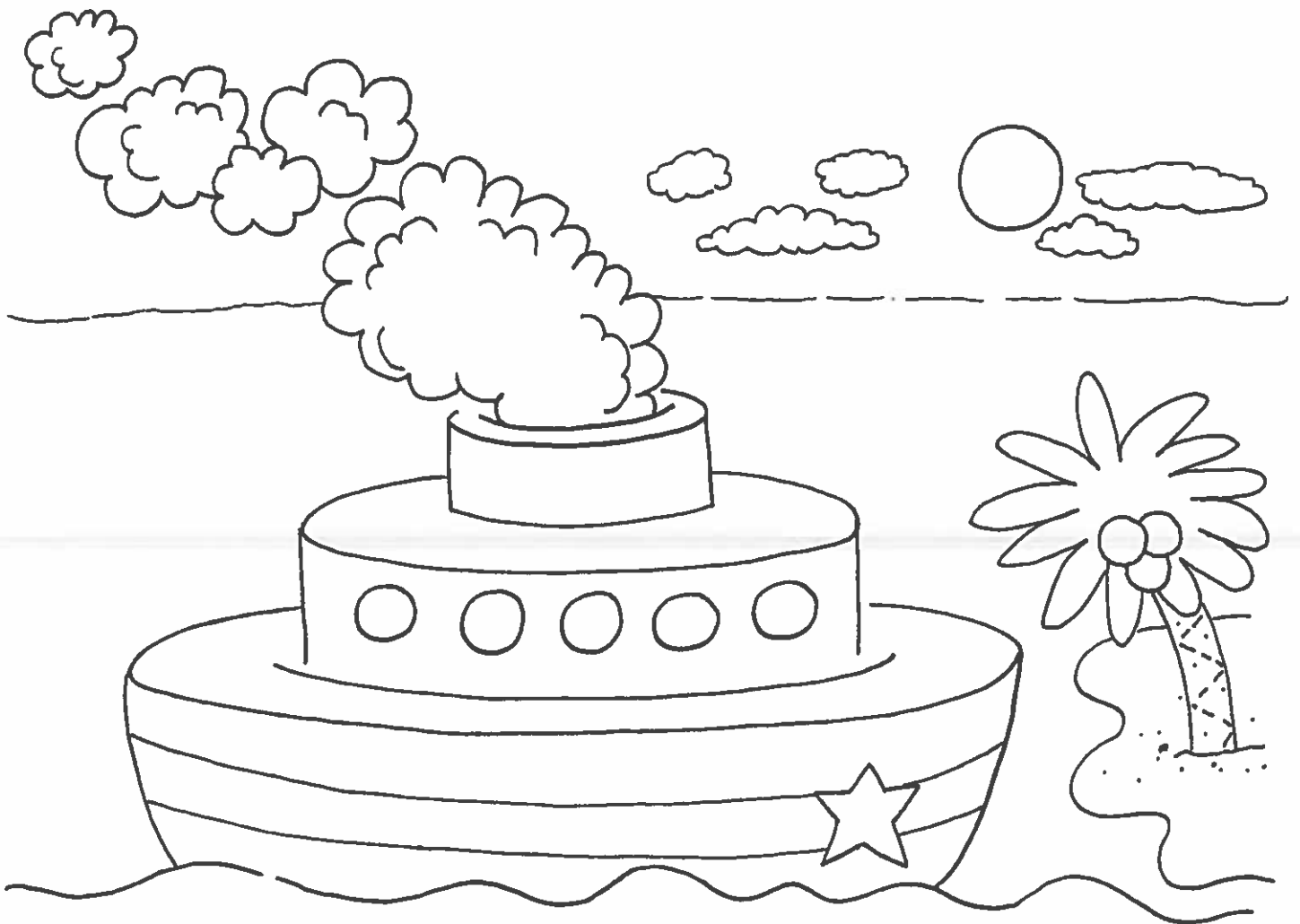

Which is above water? Which is underwater?

DRAWING

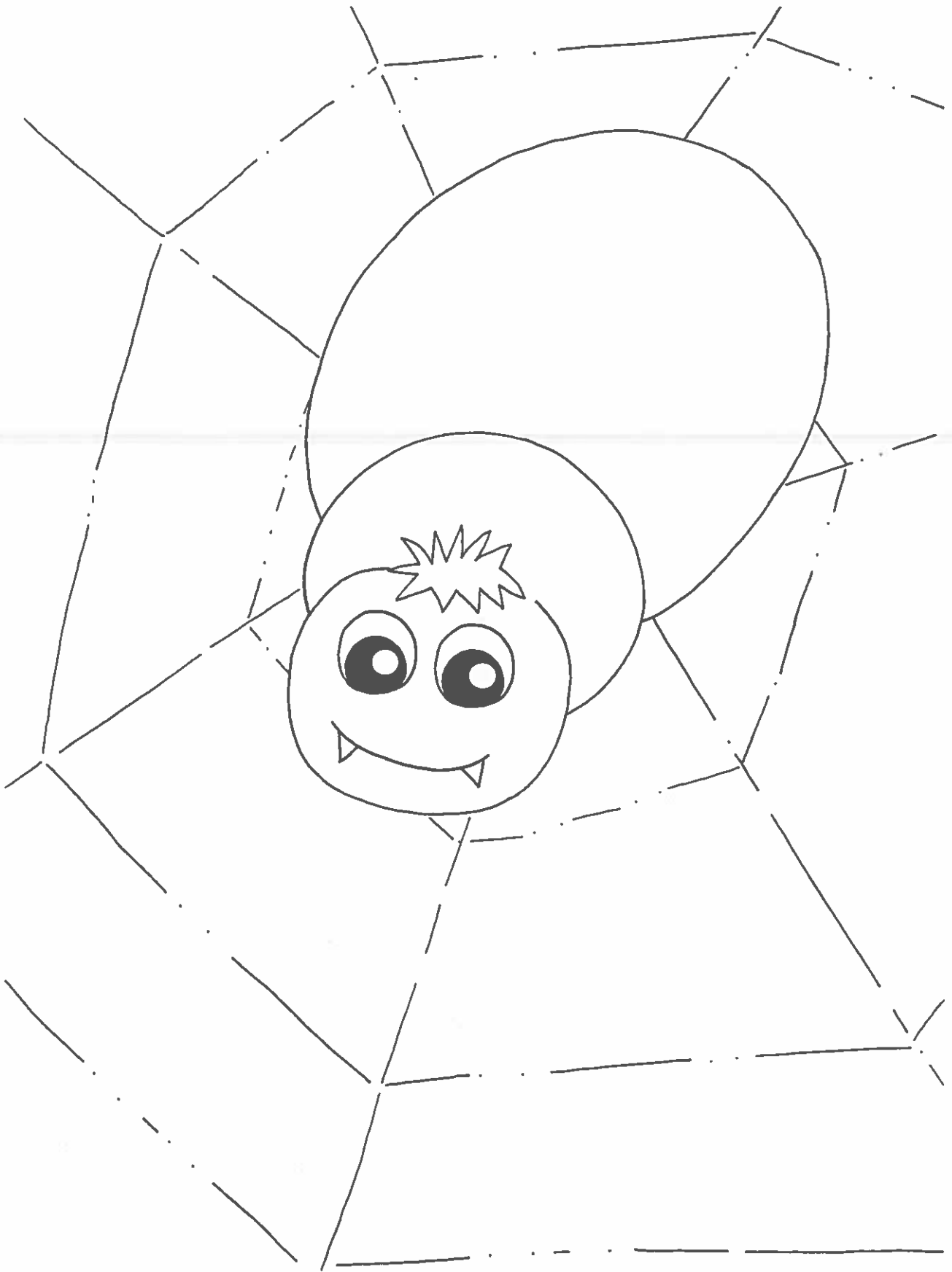

How many legs does a spider have? _____
Draw the correct amount.

MATHEMATICS

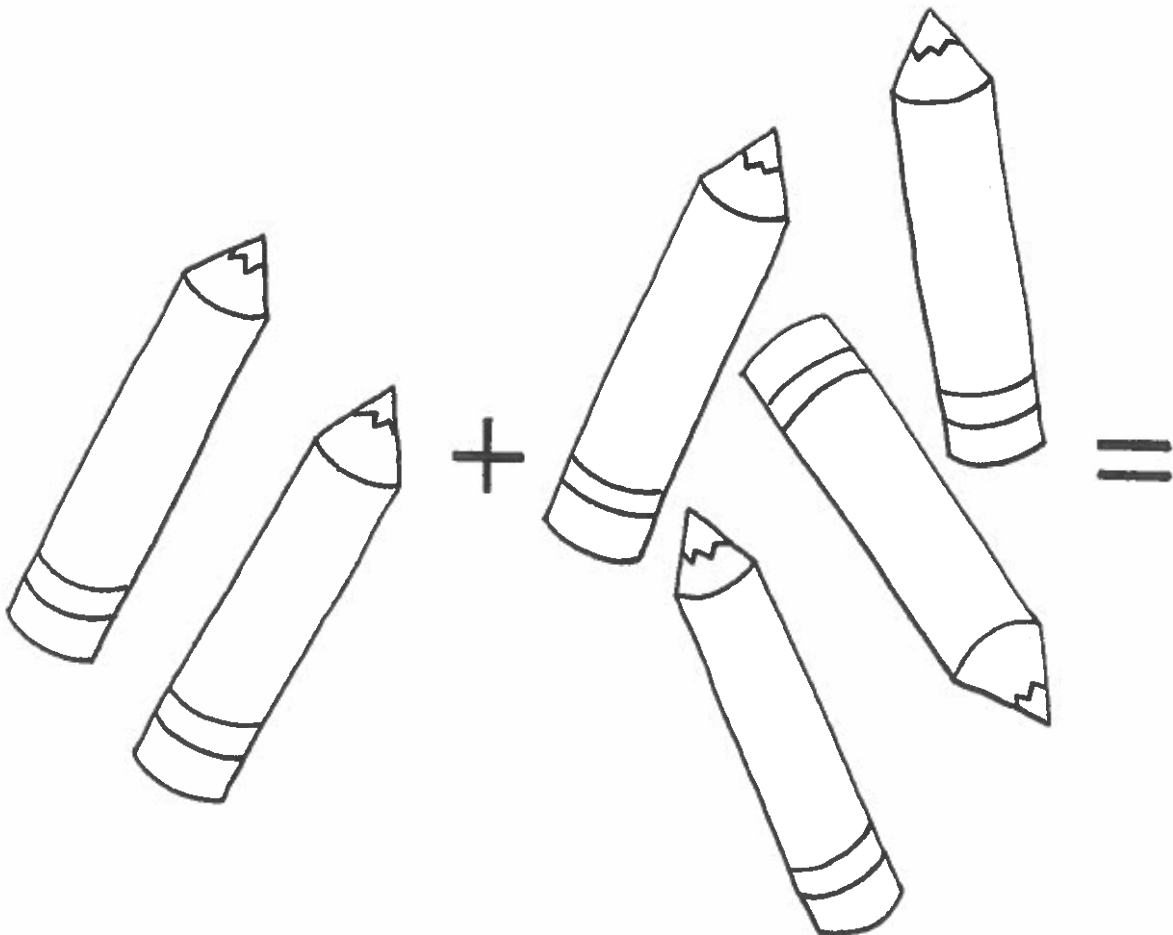
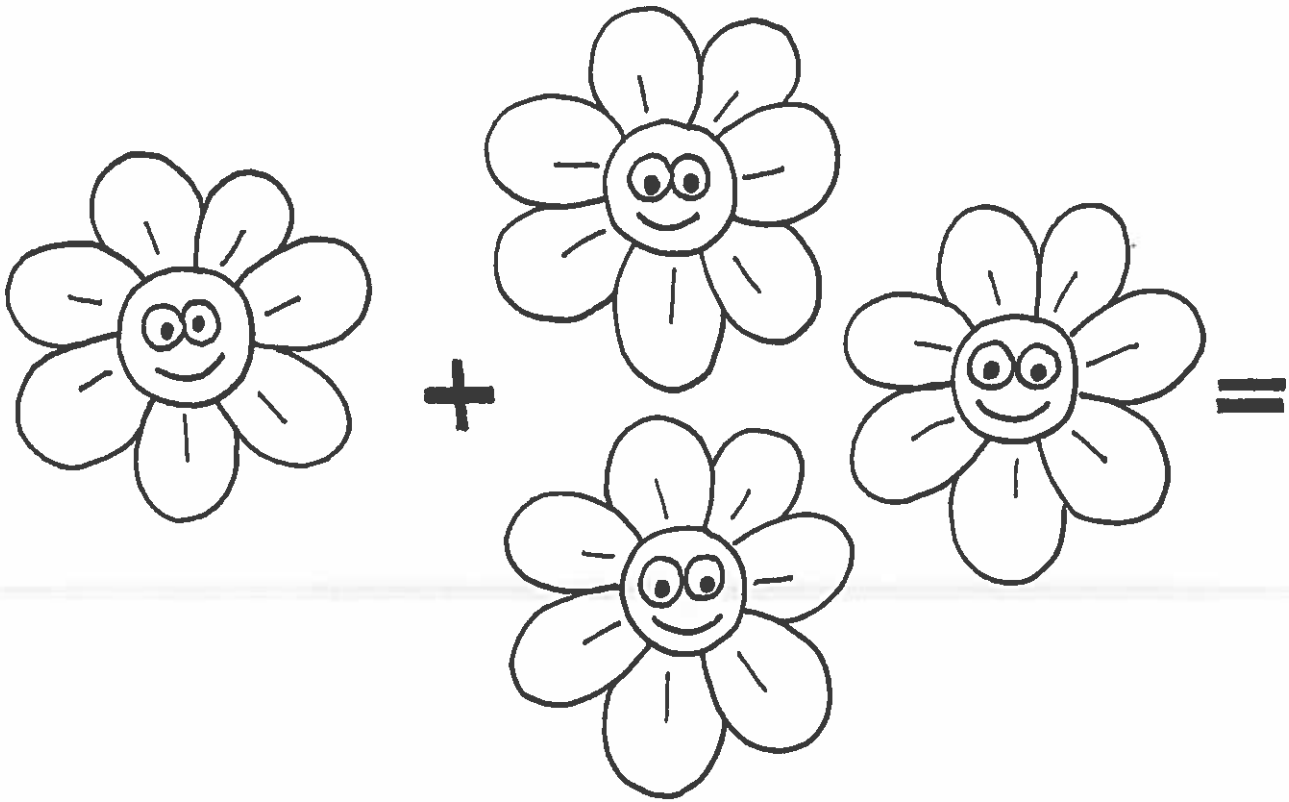

COLOURING IN

Use the correct colour for each shapes.

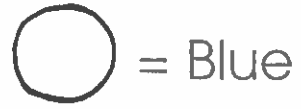
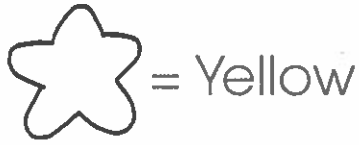

Q

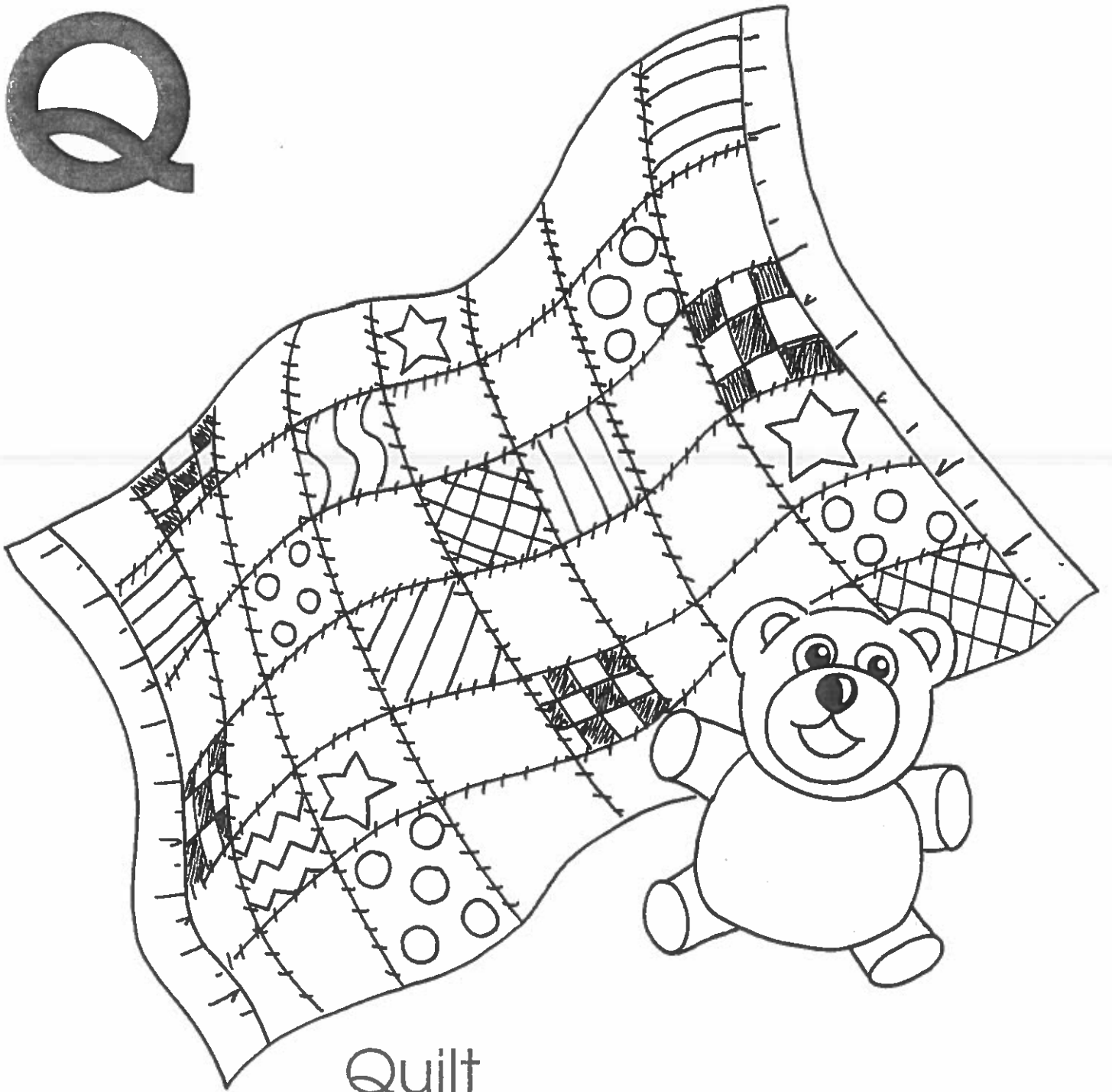

Quilt

Q

q